

Range \_\_\_\_\_  
**Bathroom drains**

 **KESSEL**



# The final touch.

Bathroom drains  
Wall drains  
Shower channels



Stylish whatever  
the design.



#### Wall drains

Clear edge. Exclusive design drains for barrier-free bathrooms.

[↗ Page 12](#)



#### Bathroom drains

Good point. Classic drains in numerous variations.

[↗ Page 18](#)



#### Shower channels

Beautiful line. Stylish drains with rim insert in timeless stainless steel design.

[↗ Page 28](#)

## Style that works.

The fact that we are stylish is confirmed by numerous design prizes. That is nice. The fact that our products work outstandingly well is confirmed daily by our customers. That is important.

Which is why we give our all day in, day out, for your satisfaction. By only using the best materials. By offering accessories for a whole range of different requirements. And by relying consistently on the highest production standards.



**High-quality materials.** The delight at a newly designed bathroom should be more than short-term. Which is why we do not compromise as far as material selection is concerned. Whether classical stainless steel or innovative compound material is involved: with our high-quality materials we guarantee the maximum possible durability and safety for our bathroom drains.



**Sensible accessories.** Typical for KESSEL: like all our products, our bathroom drains are not only pretty to look at, they are extremely versatile too. In our comprehensive range of accessories you will find the right answer to all the challenges your application presents to our drains.



**Global presence. Outstanding quality.** KESSEL drainage solutions are coveted all over the world – more than 50 export markets speak for themselves. Our global success is thanks to the quality mark “Made in Germany” to a large extent: our bathroom drains are manufactured exclusively at our main production plant in Lenting near Ingolstadt.





Bathroom drain *The Ultraflat* with design cover



Bathroom drain  
*The Ultraflat* with  
design cover



Shower channel *Linearis Comfort* 750 mm



Bathroom drain *The Ultraflat* with design cover



Wall drain *Scada*

## Clear edge.

### Wall drains

Take a firm line: the design prize-winning wall drain *Scada* is a real "eye-catcher" that gives bathrooms a quite exclusive look. Rather than being in the floor, this compact drain is set into the wall, thus creating the pre-requisites for a 100% floor-level and freely accessible shower. There is a choice of four high-grade drain covers available for *Scada* – even including versions with LED lighting!



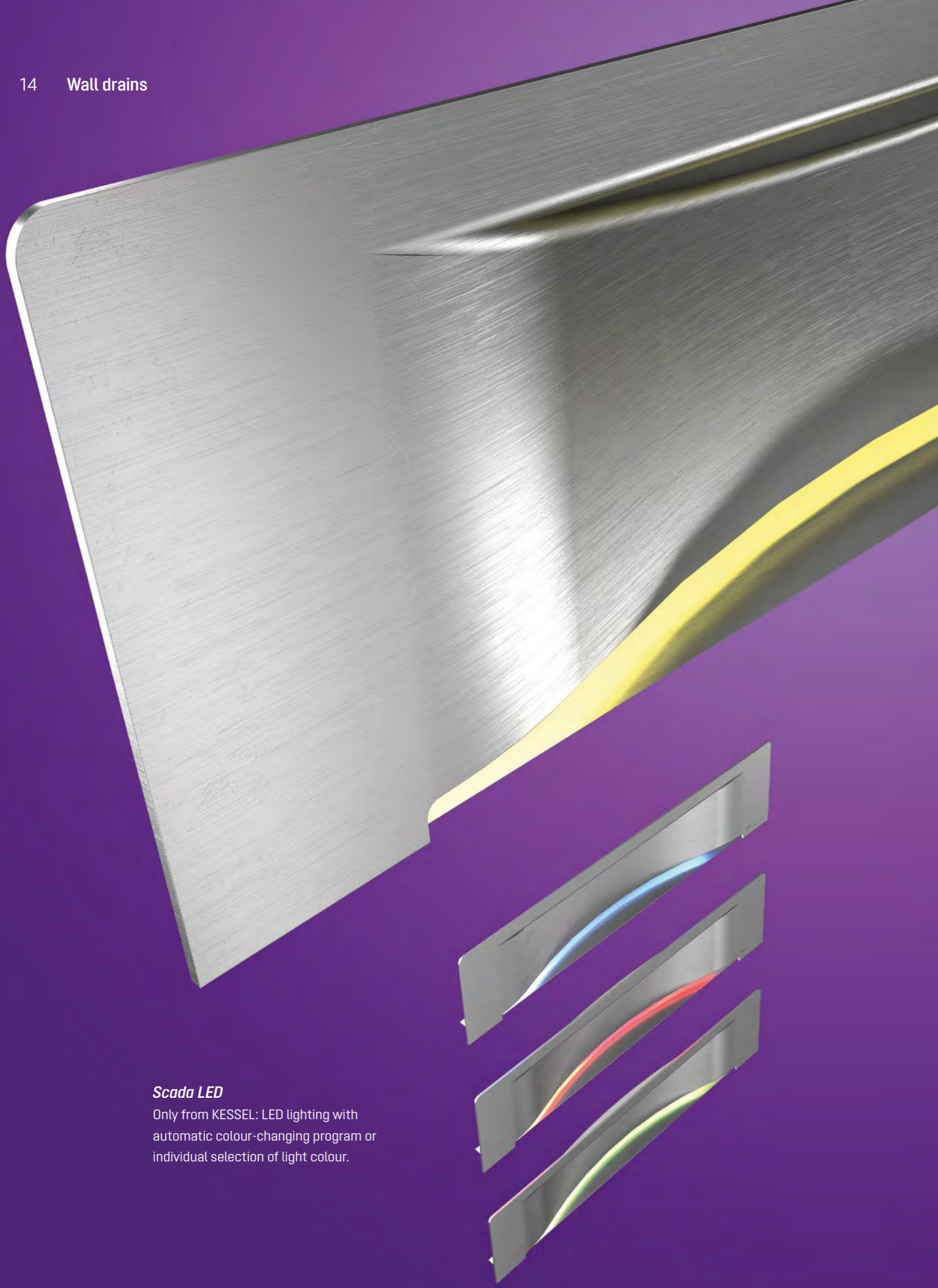

**Scada LED**

Only from KESSEL: LED lighting with automatic colour-changing program or individual selection of light colour.

## Clear advantage.

Features of our wall drains

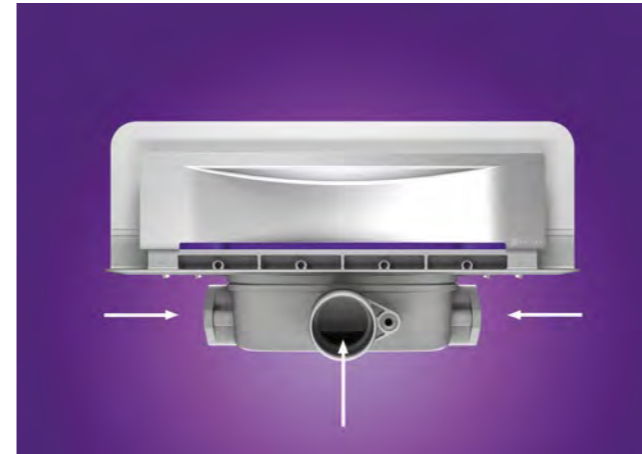

**Connections on three sides**

Thanks to different connection options (front, lateral left or right) there is no room-side twisting of the drain pipe necessary and the installation of underfloor heating underneath the shower is no problem.

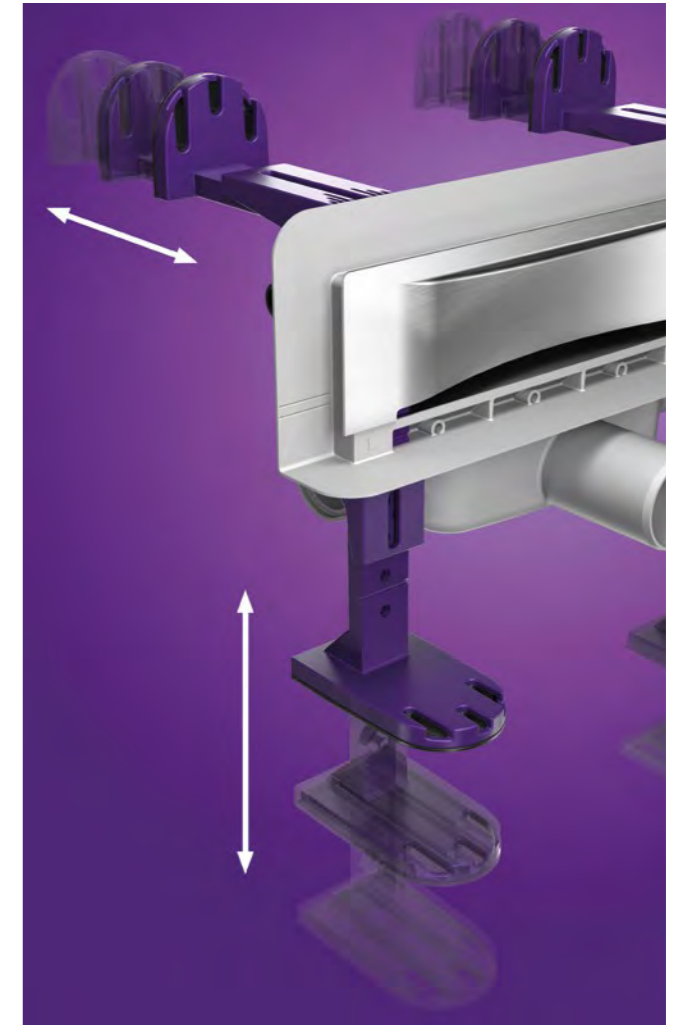

**Height-adjustable installation supports**

The height-adjustable installation supports of the dry-walling version allow convenient adjustment of the overall installation height from 80 to 215 mm up to the top edge of the tile.



# Clear decision.

Wall drains range

## Scada

The *Scada* is available with four different stainless steel drain covers. If necessary, the wall drain can also be pre-assembled and delivered sealed in an installation board. All versions offer a flow rate of 0.5 l/s.

### Scada drain covers



**Invisible**  
296 × 61 mm (W × H, tileable) for floor tiles up to 10 mm.



**Stainless steel**  
312 × 74 mm (W × H) for floor tiles up to 17 mm.



**Wave**  
312 × 74 mm (W × H) for floor tiles up to 10 mm.



**Stainless steel**  
312 × 67 mm (W × H) for floor tiles up to 10 mm.

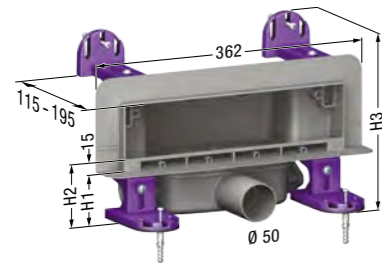

### Scada with factory-mounted waterproofing membrane

Drain cover	Art. no.
Invisible	48 000.01M
Stainless steel up to 10 mm	48 000.02M
Wave	48 000.03M
Stainless steel up to 17 mm	48 000.04M



### Scada LED with factory-mounted waterproofing membrane

Drain cover	Art. no.
Invisible	48 003.41M
Stainless steel up to 10 mm	48 003.42M
Wave	48 003.43M
Stainless steel up to 17 mm	48 003.44M

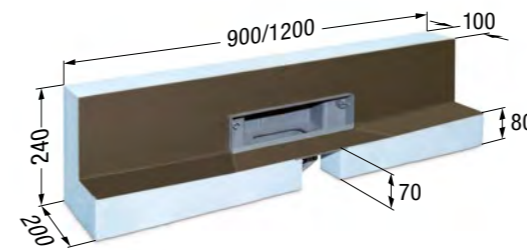

### Scada with installation board

Drain cover	Art. no.
<b>900 × 200 mm</b>	
Invisible	48 001.01
Stainless steel up to 10 mm	48 001.02
Wave	48 001.03
Stainless steel up to 17 mm	48 001.04
<b>1200 × 200 mm</b>	
Invisible	48 002.01
Stainless steel up to 10 mm	48 002.02
Wave	48 002.03
Stainless steel up to 17 mm	48 002.04



### Scada LED with installation board

Drain cover	Art. no.
<b>900 × 200 mm</b>	
Invisible	48 004.41
Stainless steel up to 10 mm	48 004.42
Wave	48 004.43
Stainless steel up to 17 mm	48 004.44
<b>1200 × 200 mm</b>	
Invisible	48 005.41
Stainless steel up to 10 mm	48 005.42
Wave	48 005.43
Stainless steel up to 17 mm	48 005.44



## Accessories

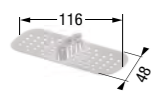

**Hair filter**  
Made of polymer.  
  
Art. no. 48 800



**Dry-walling board**  
623 × 300 mm (W × H) for post-and-beam structure. With installation adhesive.  
  
Art. no. 48 063



**Sealing gasket set**  
Adhesive and sealing strips for board elements.  
  
Art. no. 48 062

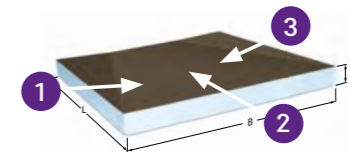

**Wedge as shower board**  
With three-sided slope. Only for *Scada*/*Scada* LED with installation board.



**Multistop**  
Waterless rodent, foam and odour stop.  
  
Art. no. 48 400

Dimensions (L × W × H)	Art. no.
<b>900 × 900 × 80 mm</b>	
① 2.4% ② 0.8% ③ 2.4%	48 051
<b>1200 × 1200 × 85 mm</b>	
① 3.7% ② 1.1% ③ 3.7%	48 052

## Good point.

### Bathroom drains

As far as classical drainage is concerned, our varied range of bathroom drains leaves nothing to be desired. No matter whether the bathroom project is in a new building, involves conversion or refurbishment work: the sophisticated functions and numerous combination options made possible by the modular principle make our bathroom drains suitable for almost all applications – and the different design covers made of stainless steel guarantee their stylish appearance.

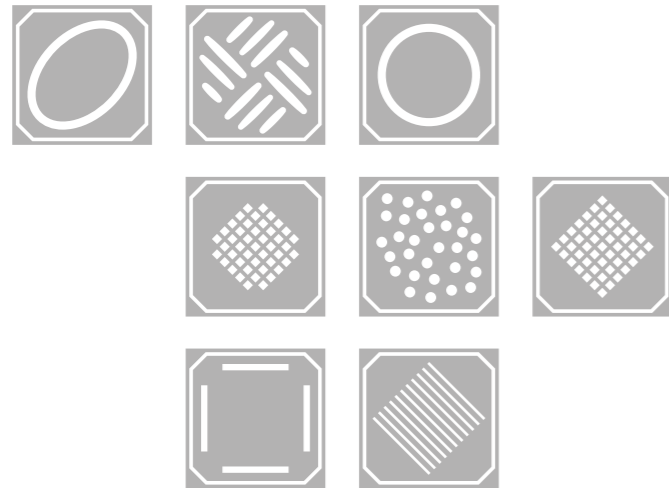

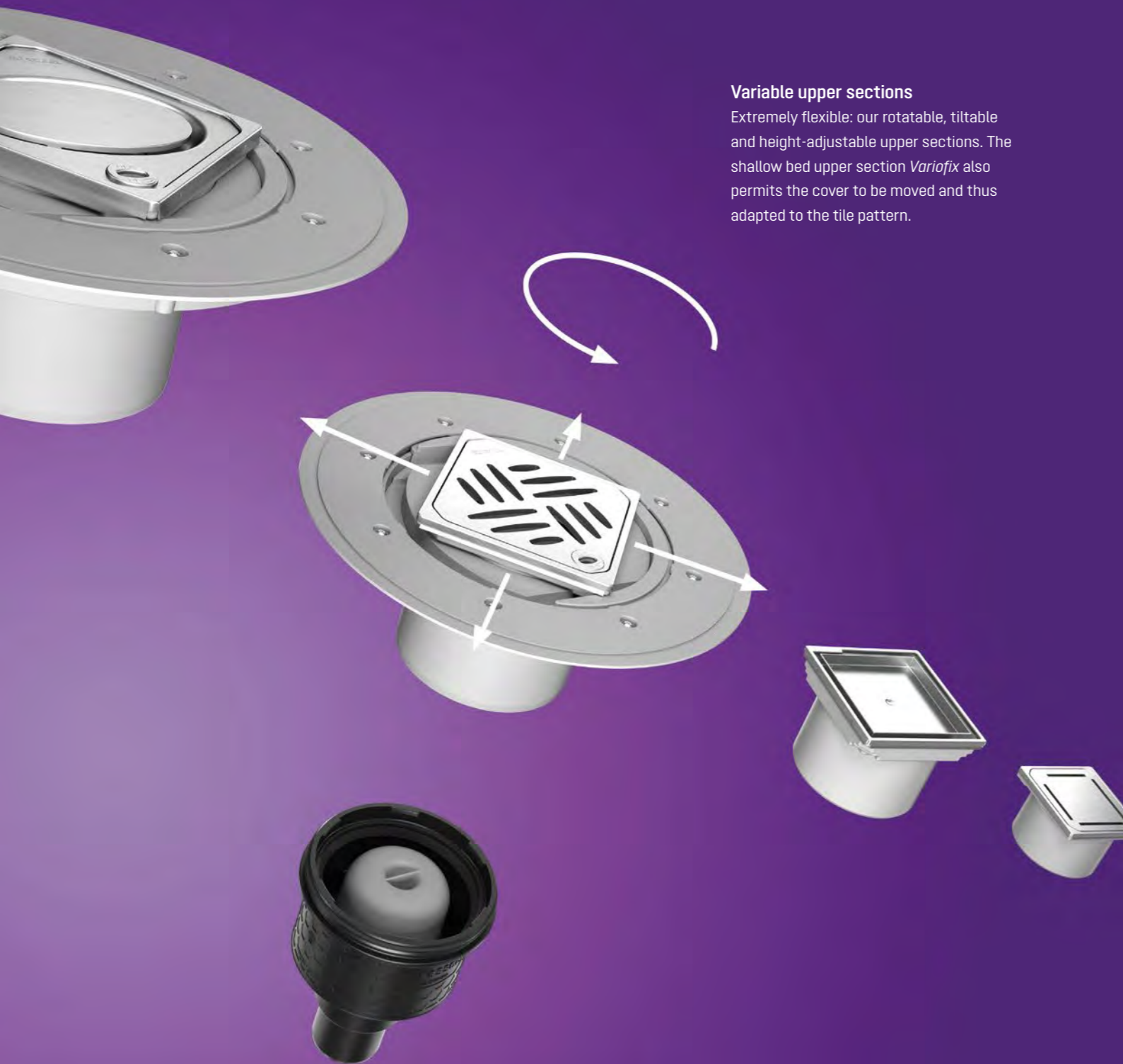

**Variable upper sections**

Extremely flexible: our rotatable, tiltable and height-adjustable upper sections. The shallow bed upper section *Variofix* also permits the cover to be moved and thus adapted to the tile pattern.

**Good thinking.**

Features of our bathroom drains



**Low installation depth**

Our low-profile bathroom drains *The Superflat* and *The Ultraflat* are particularly suitable for renovation projects thanks to their low installation depths.



**Convenient cleaning and maintenance**

The locking and removal device *Lock & Lift* makes inserting and locking or unlocking and removing the cover ultra fast. This saves time during mandatory daily cleaning in the commercial sector.

# Good choice.

Bathroom drains range

## Covers

Choose from different design covers made of stainless steel and the tileable variant *Invisible* in order to design our bathroom drains to your own taste.



# Classic

System 100

The *Classic* model is the all-rounder among our bathroom drains. Its compact size, lateral or vertical outlet and various installation options make it particularly versatile. The flow rate is 0.8 l/s.

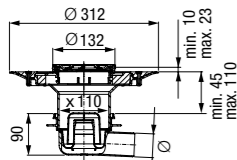

### Classic with shallow bed upper section

Outlet	Cover, class	in mm	Art. no.
<b>Ø 50</b>			
lateral	Oval, L 15	120 × 120	40 150.54
lateral	Slotted, K 3	95 × 95	40 150.50
lateral	Slotted, K 3	138 × 138	40 150.51
vertical	Oval, L 15	120 × 120	40 250.54
vertical	Slotted, K 3	100 × 100	40 250.50
vertical	Slotted, K 3	150 × 150	40 250.51
<b>Ø 75</b>			
lateral	Oval, L 15	120 × 120	40 170.54
lateral	Slotted, K 3	95 × 95	40 170.50
lateral	Slotted, K 3	138 × 138	40 170.51
vertical	Oval, L 15	120 × 120	40 270.54
vertical	Slotted, K 3	95 × 95	40 270.50
vertical	Slotted, K 3	138 × 138	40 270.51

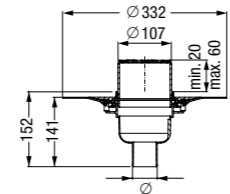

### Classic with removable odour trap, with glued flange

Outlet	Cover, class	in mm	Art. no.
<b>Ø 50</b>			
lateral	Slotted, K 3	100 × 100	40 150.90
vertical	Slotted, K 3	100 × 100	40 250.90
<b>Ø 75</b>			
lateral	Slotted, K 3	100 × 100	40 170.90
vertical	Slotted, K 3	100 × 100	40 270.90

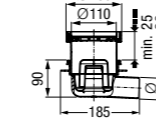

### Classic with removable odour trap

Outlet	Cover, class	in mm	Art. no.
<b>Ø 50</b>			
lateral	Invisible, K 3	110 × 110	40 150.66
lateral	Slotted, K 3	100 × 100	40 150.20
vertical	Invisible, K 3	110 × 110	40 250.66
vertical	Slotted, K 3	100 × 100	40 250.20
<b>Ø 75</b>			
lateral	Invisible, K 3	110 × 110	40 170.66
lateral	Slotted, K 3	100 × 100	40 170.20
vertical	Invisible, K 3	110 × 110	40 270.66
vertical	Slotted, K 3	100 × 100	40 270.20

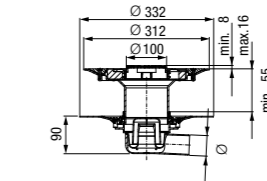
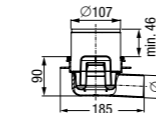

### Classic with double waterproofing layer

Outlet	Cover, class	in mm	Art. no.
<b>Ø 50</b>			
lateral	Slotted, K 3	95 × 95	40 159.50
vertical	Slotted, K 3	95 × 95	40 259.50
<b>Ø 75</b>			
lateral	Slotted, K 3	95 × 95	40 179.50
vertical	Slotted, K 3	95 × 95	40 279.50

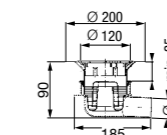

### Classic with clamped flange

Outlet	Cover, class	in mm	Art. no.
<b>Ø 50</b>			
lateral	Slotted, K 3	120 × 120	40 150.30
vertical	Slotted, K 3	120 × 120	40 250.30
<b>Ø 75</b>			
lateral	Slotted, K 3	120 × 120	40 170.30
vertical	Slotted, K 3	120 × 120	40 270.30

# The Superflat

System 100

With its low overall height of 90 mm including cover, *The Superflat* is especially suitable for low installation depths. The upper section can be shortened according to requirements. The flow rate is 0.8 l/s, the outlet is lateral



**The Superflat with removable odour trap, with glued flange**

Outlet	Cover, class	in mm	Art. no.
Ø 50			
lateral	Slotted, K 3	100 × 100	42 701.91

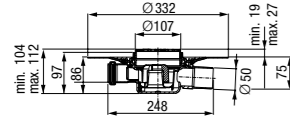

**The Superflat with removable odour trap, with glued flange**

Outlet	Cover, class	in mm	Art. no.
Ø 50			
lateral	Invisible, K 3	110 × 110	42 701.95

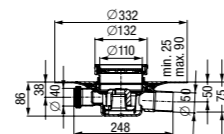

**The Superflat with removable odour trap, with Variofix shallow bed upper section**

Outlet	Cover, class	in mm	Art. no.
Ø 50			
lateral	Oval, L 15	120 × 120	42 701.54
lateral	Slotted, K 3	95 × 95	42 701.50

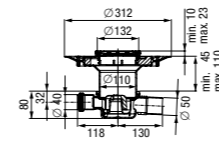

**The Superflat with removable odour trap**

Outlet	Cover, class	in mm	Art. no.
Ø 50			
lateral	Slotted, K 3	100 × 100	42 701.20

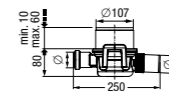

# Floordrain ME

System 100

Modular design

Drain body  
**Floordrain ME**



With three inlets Ø 55 mm and one outlet Ø 75 mm, with removable odour trap. The flow rate is 1.8 l/s.

Art. no. 373 001

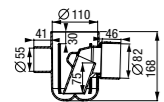

Upper sections



Cover	in mm	Lock & Lift	Art. no.
<b>Class L 15</b>			
Kessel	120 × 120	with	27 201
Kessel	120 × 120	without	27 225
Oval	120 × 120	with	27 202
Oval	120 × 120	without	27 226

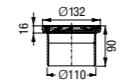

Cover	in mm	Lock & Lift	Art. no.
<b>Class K 3</b>			
Spot	120 × 120	with	27 221
Spot	120 × 120	without	27 220
Cross	120 × 120	with	27 213
Cross	120 × 120	without	27 212
Parade	120 × 120	with	27 215
Parade	120 × 120	without	27 214
Slot	120 × 120	with	27 219
Slot	120 × 120	without	27 218
Sticks	120 × 120	with	27 217
Sticks	120 × 120	without	27 216

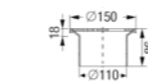
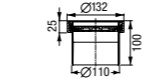

Cover, class	in mm	Features	Art. no.
Invisible, K 3	110 × 110	Rim stainless steel	27 211
Invisible, K 3	110 × 110	—	27 210

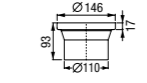

Cover, class	in mm	Features	Art. no.
Closed, L 15	150 × 150	Rim and cover stainless steel	27 1966

Cover, class	in mm	Features	Art. no.
Slotted, K 3	138 × 138	non-slip	27 176
Slotted, K 3	138 × 138	—	27 196

# The Ultraflat System 125

The name speaks for itself: the *The Ultraflat* is our flattest bathroom drain and thus perfect for renovation work in existing buildings. It offers a flow rate of 0.6 to 1.0 l/s.



<i>The Ultraflat 54</i> with factory-mounted waterproofing membrane	Cover, class	Features	Art. no.
<b>Ø 40, lateral outlet, cover 120 × 120 mm</b>			
Slotted, K 3	—	—	44 740.20M
Kessel, L 15	—	—	44 740.62M
Kessel, L 15	—	Lock & Lift	44 740.63M
Kessel, L 15	—	Lock & Lift	44 740.66M
<b>Ø 50, lateral outlet, cover 120 × 120 mm</b>			
Slotted, K 3	—	—	44 750.20M
Kessel, L 15	—	—	44 750.62M
Kessel, L 15	—	Lock & Lift	44 750.63M
Kessel, L 15	—	Lock & Lift	44 750.66M

<i>The Ultraflat 54</i> with non-mounted waterproofing membrane	Cover, class	Features	Art. no.
<b>Ø 40, lateral outlet, cover 120 × 120 mm</b>			
Slotted, K 3	—	—	44 740.20
Kessel, L 15	—	—	44 740.62
Kessel, L 15	—	Lock & Lift	44 740.63
<b>Ø 50, lateral outlet, cover 120 × 120 mm</b>			
Slotted, K 3	—	—	44 750.20
Kessel, L 15	—	—	44 750.62
Kessel, L 15	—	Lock & Lift	44 750.63

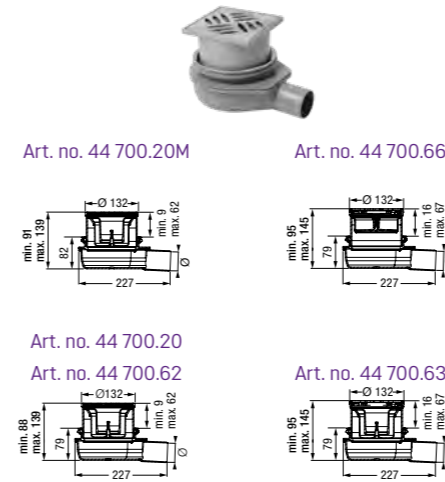

<i>The Ultraflat 79</i> without waterproofing membrane	Cover, class	Features	Art. no.
<b>Ø 50, lateral outlet, cover 120 × 120 mm</b>			
Slotted, K 3	—	—	44 700.20
Kessel, L 15	—	—	44 700.62
Kessel, L 15	—	Lock & Lift	44 700.63
Kessel, L 15	—	Lock & Lift, Megastop	44 700.66

  

<i>The Ultraflat 79</i> with <i>Variofix</i> shallow bed upper section and non-mounted waterproofing membrane	Cover, class	Features	Art. no.
<b>Ø 50, lateral outlet, cover 120 × 120 mm</b>			
Slotted, K 3	—	—	44 700.51
Kessel, L 15	—	—	44 700.52
Kessel, L 15	—	Lock & Lift	44 700.53

<i>The Ultraflat 79</i> incl. clips flange with factory-mounted waterproofing membrane	Cover, class	Features	Art. no.
<b>Ø 50, lateral outlet, cover 120 × 120 mm</b>			
Slotted, K 3	—	—	44 700.20M

# Accessories System 100 System 125

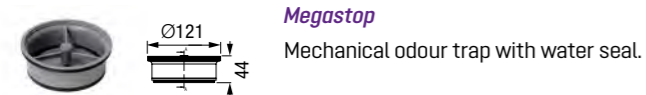

**Megastop**  
Mechanical odour trap with water seal.

Suitable for	System	Art. no.
<i>The Ultraflat</i>	125	48 550

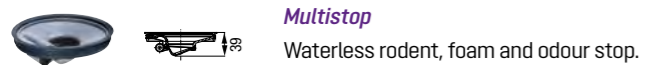

**Multistop**  
Waterless rodent, foam and odour stop.

Suitable for	System	Art. no.
<i>Classic, The Superflat</i>	100	43 500
<i>The Ultraflat</i>	125	48 500

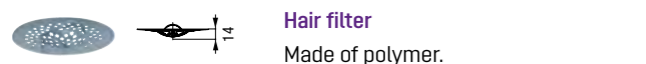

**Hair filter**  
Made of polymer.

Suitable for	System	Art. no.
<i>Classic, The Superflat</i>	100	43 700
<i>The Ultraflat</i>	125	48 700

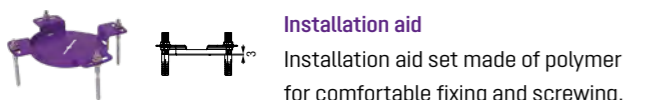

**Installation aid**  
Installation aid set made of polymer for comfortable fixing and screwing.

Suitable for	System	Art. no.
<i>The Ultraflat</i>	125	44 702

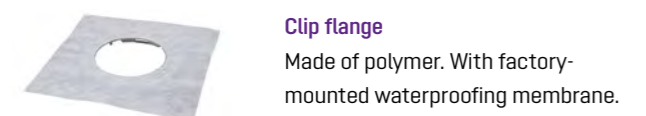

**Clip flange**  
Made of polymer. With factory-mounted waterproofing membrane.

Suitable for	System	Art. no.
<i>The Ultraflat</i>	125	44 703

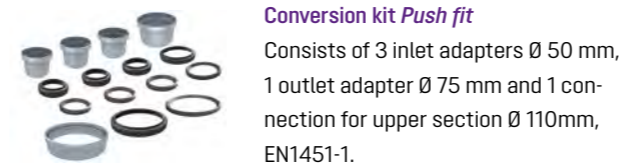

**Conversion kit Push fit**  
Consists of 3 inlet adapters Ø 50 mm, 1 outlet adapter Ø 75 mm and 1 connection for upper section Ø 110mm, EN1451-1.

Suitable for	System	Art. no.
<i>Floordrain ME</i>	100	373 008

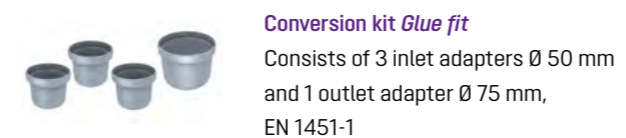

**Conversion kit Glue fit**  
Consists of 3 inlet adapters Ø 50 mm and 1 outlet adapter Ø 75 mm, EN 1451-1

Suitable for	System	Art. no.
<i>Floordrain ME</i>	100	373 007

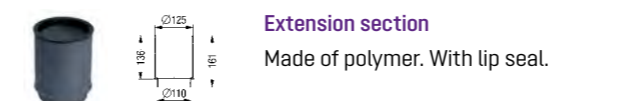

**Extension section**  
Made of polymer. With lip seal.

Suitable for	System	Art. no.
<i>Classic, The Superflat</i>	100	27 146

## Beautiful line.

### Shower channels

Good design is timeless – our shower channels *Linearis* are certainly no exception to this. Their reduced design and high-quality stainless steel make them an optical highlight that you will never tire of seeing. And even if you do, the shower channels can simply be redesigned for a new look thanks to their turnable and tileable stainless steel cover. No matter what: with *Linearis* roomside or near to the wall there are quite literally no limits to barrier-free shower convenience.



**Individual design**

The turnable and tileable stainless steel cover allows the shower channel to be contrasted with the floor as an eye-catcher or integrated as discretely as possible.

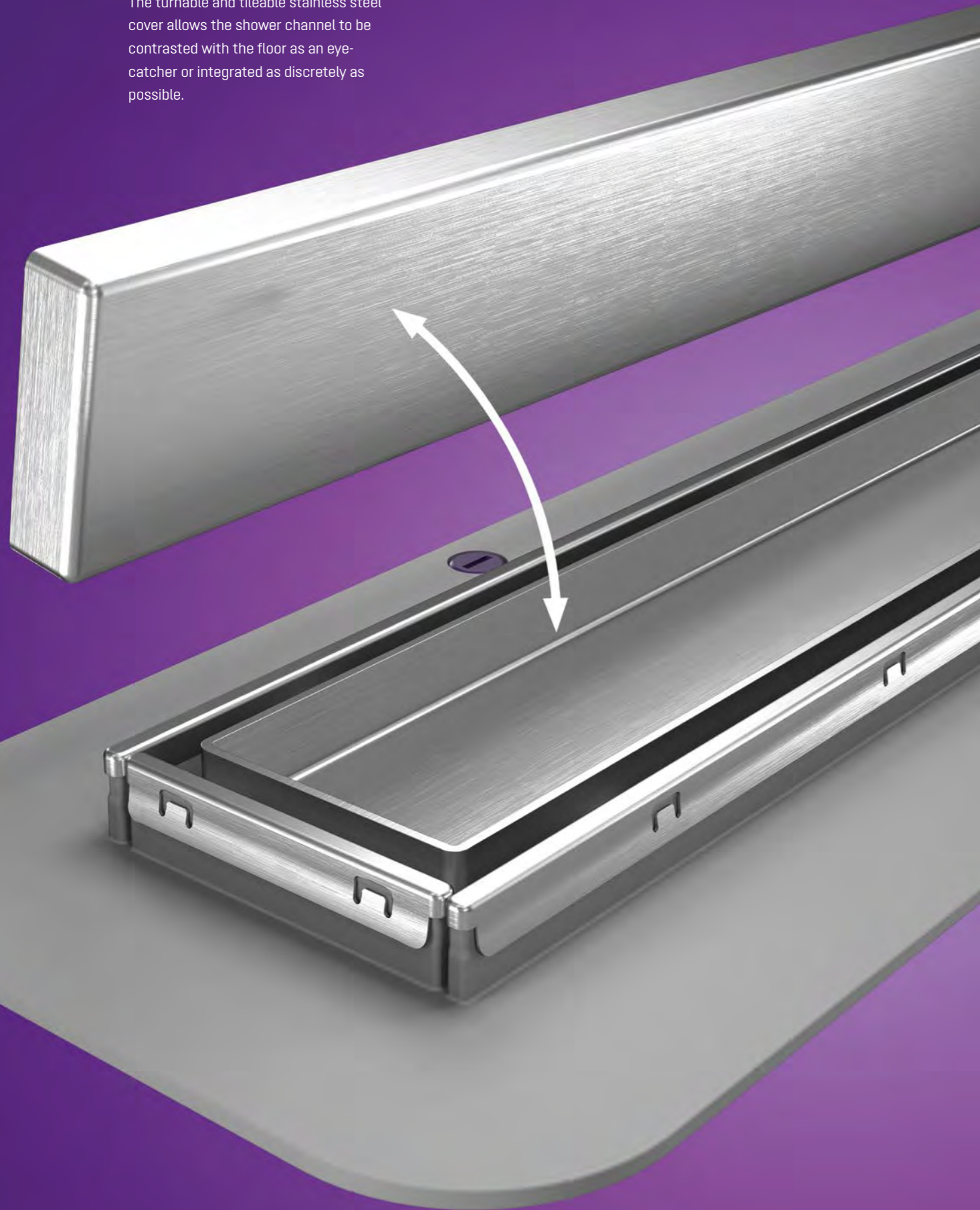

## Beautifully practical.

Features of our shower channels

**Height-adjustable installation supports**

Thanks to the gradual height adjustment of the installation supports, the installation height can be freely adapted to the floor level.

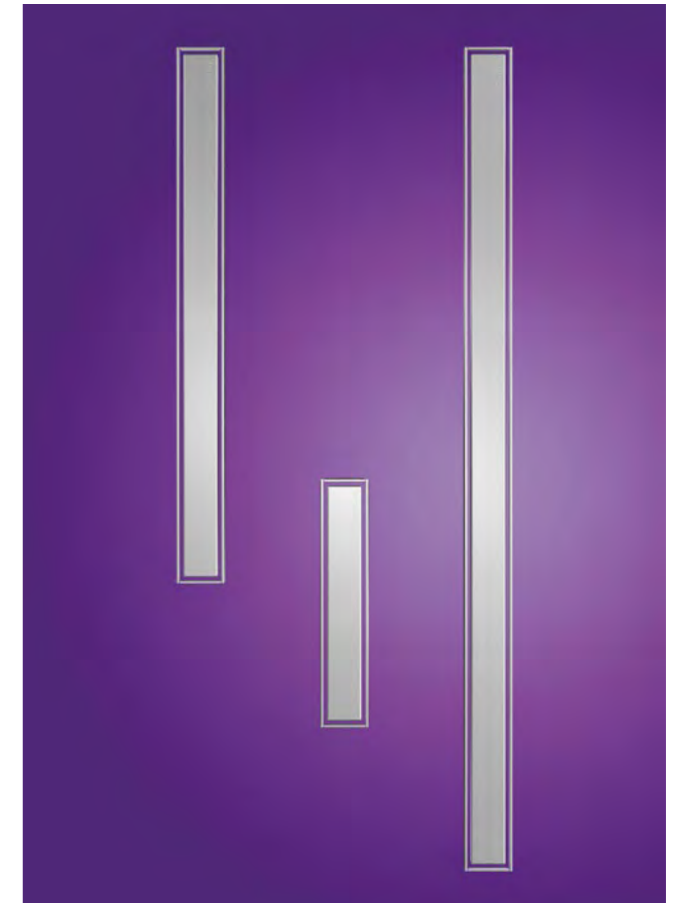
**Different channel lengths**

Our shower channels are available in lengths of 300 to 1150 mm and can thus be used in differently dimensioned shower areas.



# Beautifully versatile.

Shower channels range

## Linearis Comfort

The elegant solution: the *Linearis Comfort* with factory-mounted waterproofing membrane is our premium shower channel for maximum showering convenience. It provides a barrier-free experience, best sound-proofing features and a flow rate of 1.1 l/s / 1.0 l/s with 10 mm / 0 mm water head.

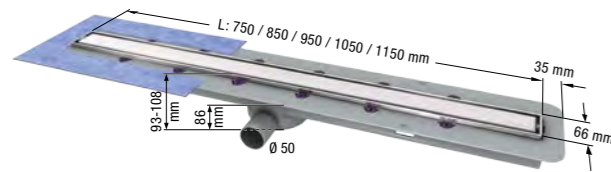

### Linearis Comfort

Length (mm)	Art. no.
750	45 600.83M
850	45 600.84M
950	45 600.85M
1050	45 600.86M
1150	45 600.87M

## Linearis Compact

Our shower channel *Linearis Compact* with non-mounted waterproofing membrane is a dream for all those who value puristic, timeless design in the bathroom. Its compact height also makes it suitable for renovation work and a flow rate of 0.6 l/s / 0.5 l/s with 10 mm / 0 mm water head.

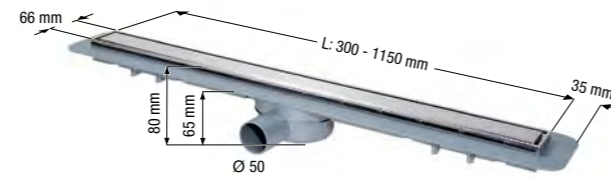

### Linearis Compact with non-mounted waterproofing membrane

Length (mm)	Art. no.
300	45 600.59
450	45 600.60
550	45 600.61
650	45 600.62
750	45 600.63
850	45 600.64
950	45 600.65
1050	45 600.66
1150	45 600.67

### Linearis Compact with factory-mounted waterproofing membrane

Length (mm)	Art. no.
300	45 600.59M
450	45 600.60M
550	45 600.61M
650	45 600.62M
750	45 600.63M
850	45 600.64M
950	45 600.65M
1050	45 600.66M
1150	45 600.67M

## Linearis Compact

System 100

### Modular design

The *Linearis Compact* with non-mounted waterproofing membrane can also be delivered as an upper section that can be combined with all drain bodies and accessory parts of the modular system 100.



### Upper section Linearis Compact

Length (mm)	Art. no.
300	47 804S
450	47 805S
550	47 806S
650	47 807S
750	47 808S
850	47 809S
950	47 810S
1050	47 811S
1150	47 812S



### Drain body Classic Ø 50, without odour trap

Outlet	Art. no.
<b>Ø 50</b>	
lateral	40 151
vertical	40 251
<b>Ø 75</b>	
lateral	40 171
vertical	40 271

## Accessories



### Multistop

Waterless rodent, foam and odour stop.

Art. no. 48 400

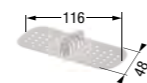

### Hair filter

Made of polymer.

Art. no. 48 800



### Installation aid

Installation aid can be shortened individually as screed substitute. With installation adhesive.

Product	Art. no.
<i>Linearis Comfort</i>	48 640
<i>Linearis Compact</i>	48 639



## A company with style.

Since 1963, KESSEL has stood like no other company for innovative and safe drainage technology. We have established ourselves as the impulse generator of the branch for decades and are now a premium international supplier.



KESSEL factory grounds, Lenting



**500+**  
employees



**€ 103 million**  
annual turnover (2018)



**92,920 m<sup>2</sup>**  
factory space



**54**  
export markets

Alongside continuous quality assurance, environmental protection, energy efficiency as well as health and safety at work are especially important to us – both in production and during the operation of our products in the field.

We also set great store by sustainability in our customer relations. For this reason, we offer a unique range of services from consultation and planning through installation and commissioning to regular maintenance.

One thing is certain: we remain with quality, innovation, safety and service at the top among the leaders in technology development to live up to our vision again and again:

KESSEL – Leading in drainage

 **Made in Germany**

## Leading in drainage.

No matter whether the task involves discharging water, wastewater treatment or backwater protection: if the best solution is required, there is no option but KESSEL.

**Backwater protection**

**Lifting stations and pumps**

**Separating technology**

**Drainage technology**

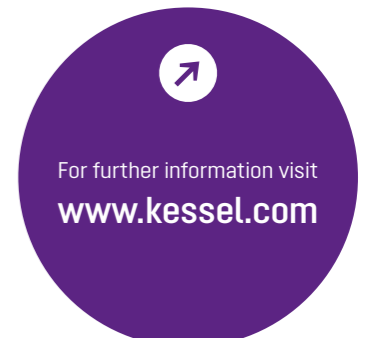



Subject to technical modifications.

**KESSEL AG**

Bahnhofstraße 31 • 85101 Lenting • Germany

[www.kessel.com](http://www.kessel.com)